

USER MANUAL



expondo.com

BEDIENUNGSANLEITUNG
INSTRUKCJA OBSŁUGI
NÁVOD K POUŽITÍ
MANUEL D'UTILISATION
ISTRUZIONI PER L'USO
MANUAL DE INSTRUCCIONES













PHYSA ILFORD DARK BROWN

BARBER CHAIR

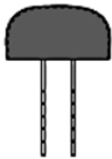
INHALT | CONTENT | TREŚĆ | OBSAH | CONTENU | CONTENUTO | CONTENIDO

PRODUKTNAME	FRISEURSTUHL
PRODUCT NAME	BARBER CHAIR
NAZWA PRODUKTU	KRZESŁO FRYZJERSKIE
NÁZEV VÝROBKU	KADEŘNICKÉ KŘESLO
NOM DU PRODUIT	FAUTEUIL DE COIFFURE
NOME DEL PRODOTTO	SEDIA DA PARRUCCHIERE
NOMBRE DEL PRODUCTO	SILLÓN DE PELUQUERÍA
MODELL	
PRODUCT MODEL	
MODEL PRODUKTU	
MODEL VÝROBKU	PHYSA ILFORD DARK BROWN
MODÈLE	
MODELLO	
MODELO	
MAXIMALE BELASTBARKEIT	
MAXIMUM LOAD	
MAKSYMALNE OBCIĄŻENIE	
MAXIMÁLNÍ NOSNOST	150 KG
CAPACITÉ DE CHARGE MAXIMALE	
CAPACITÀ DI CARICO MASSIMA	
CARGA MÁXIMA	
HERSTELLER	
MANUFACTURER	
PRODUCENT	
VÝROBCE	EXPONDO POLSKA SP. Z O.O. SP. K.
FABRICANT	
PRODUTTORE	
FABRICANTE	
ANSCHRIFT DES HERSTELLERS	
MANUFACTURER ADDRESS	
ADRES PRODUCENTA	
ADRESA VÝROBCE	UL. NOWY KISIELIN – INNOWACYJNA 7, 66-002 ZIELONA GÓRA POLAND, EU
ADRESSE DU FABRICANT	
INDIRIZZO DEL PRODUTTORE	
DIRECCIÓN DEL FABRICANTE	

 KOMponenten des Sets | Kit Elements | Elementy Zestawu | Součásti Dodávky
 Éléments de l'ensemble | Componenti del kit | Elementos del conjunto

Ax1 	Bx1 	Cx1 
Dx1 	Ex1 	Hx1 
Ix1 	Jx1 	Kx3 
Lx2 	Mx1 	Nx3 

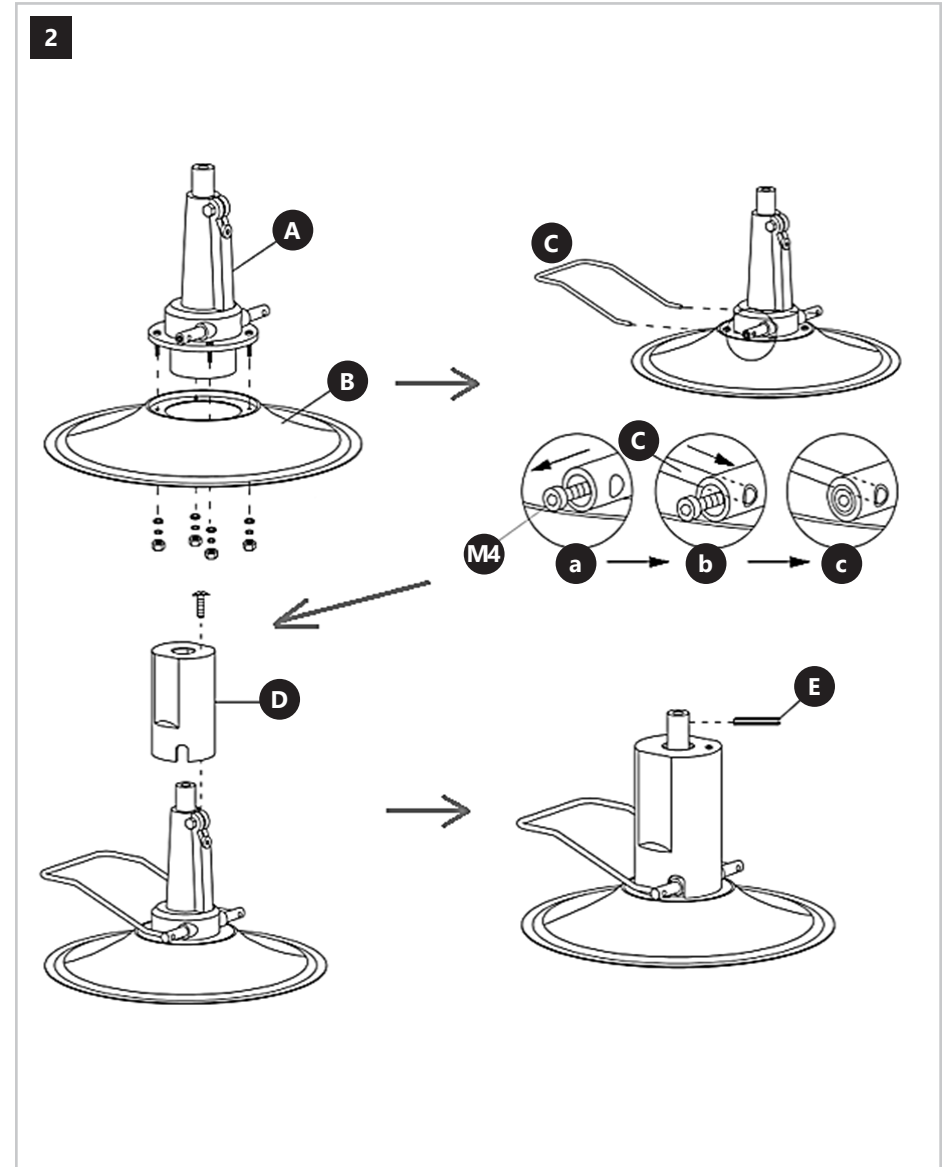
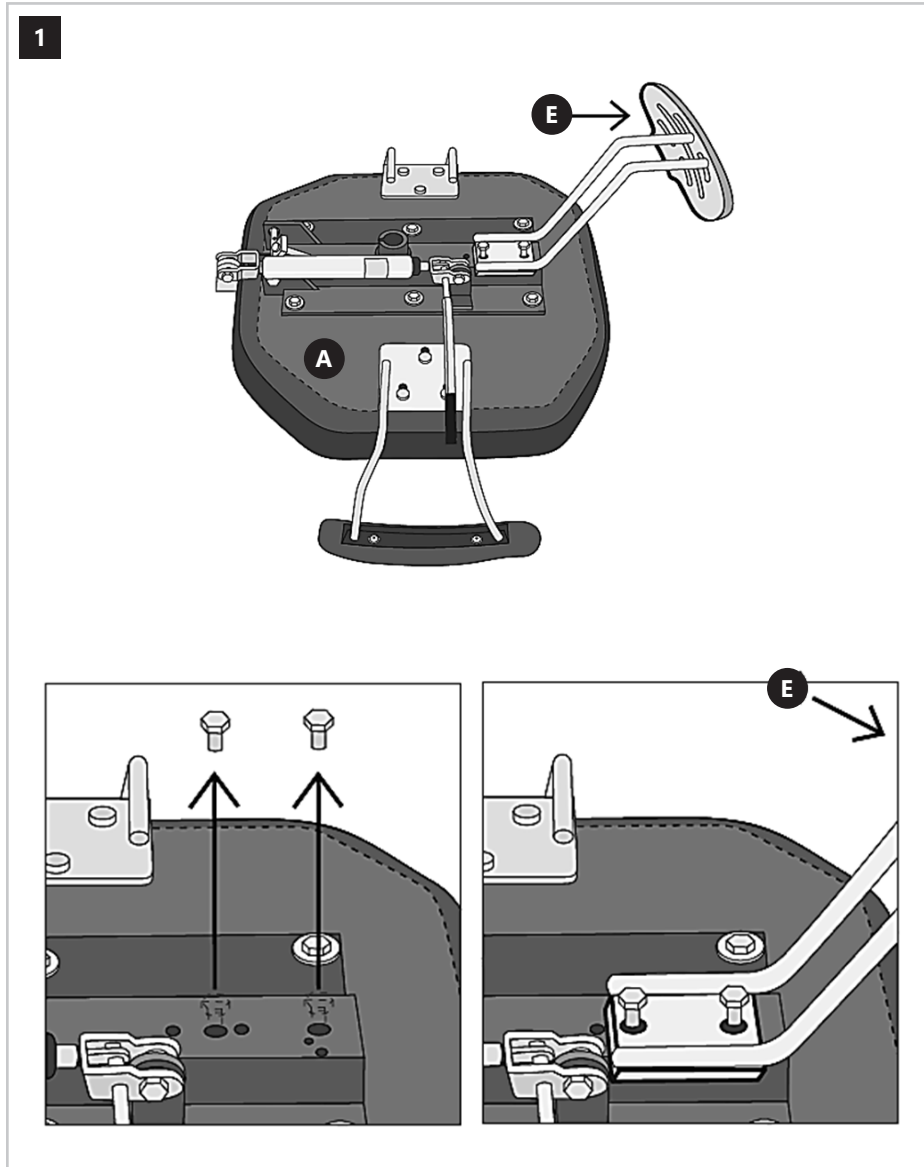

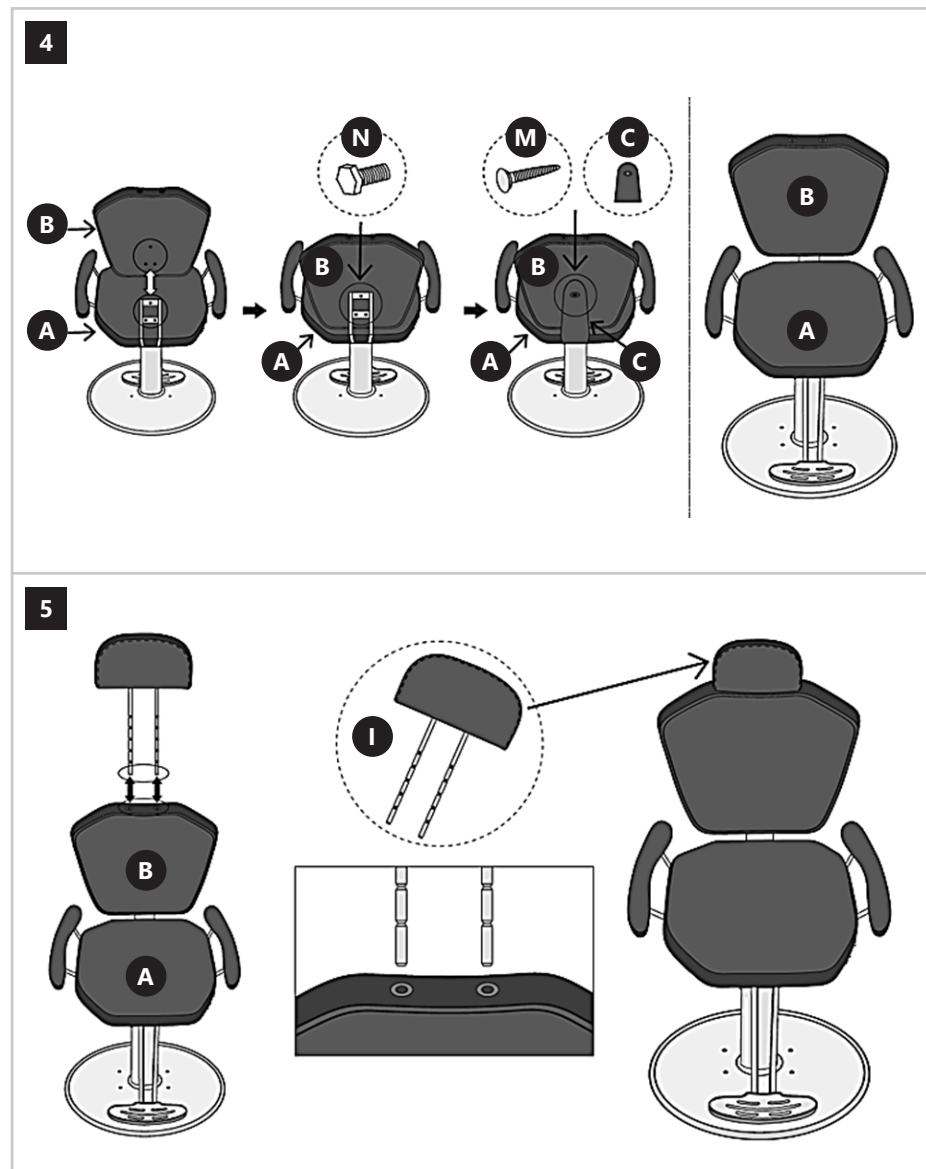
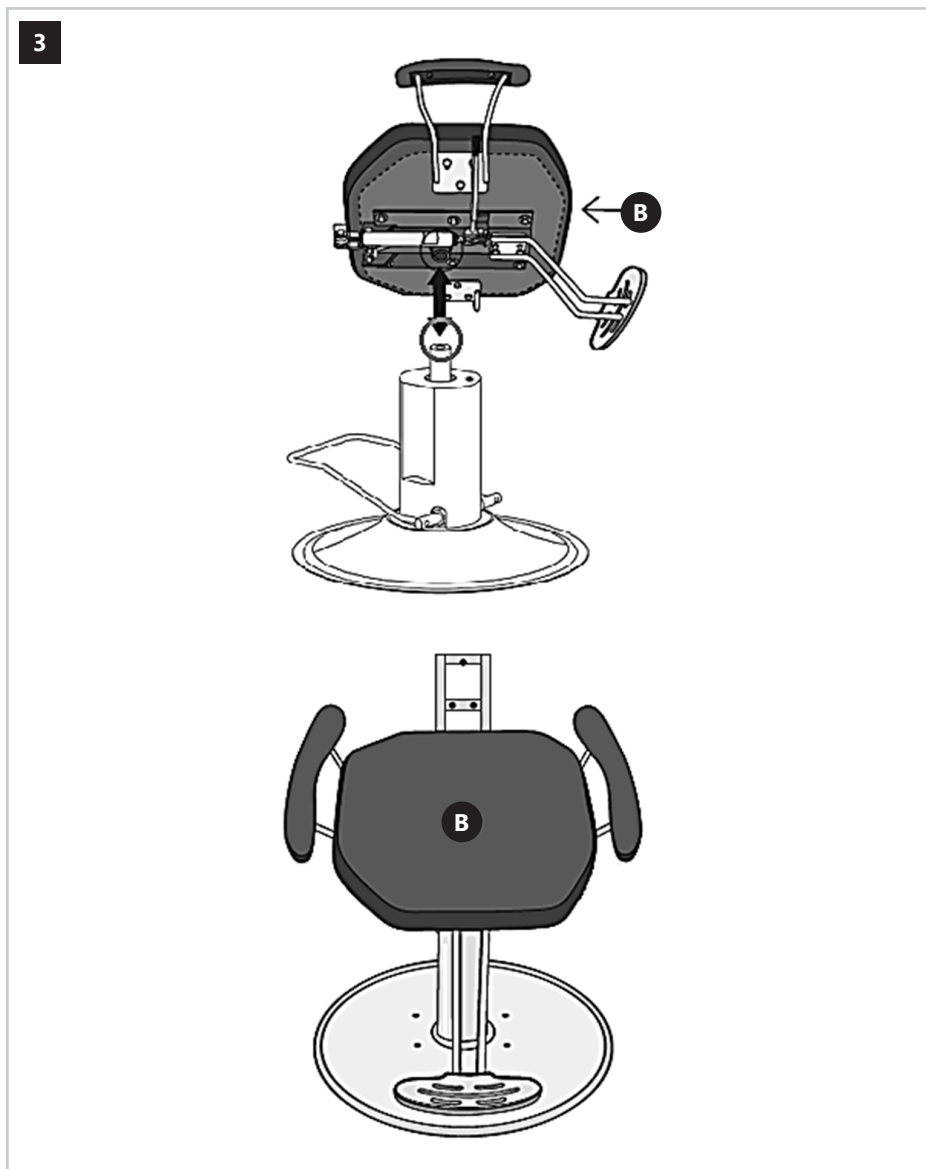



Our customers' satisfaction is our main goal!

Please contact us with questions AT:

Unser Hauptziel ist die Zufriedenheit unserer Kunden!

bei fragen kontaktieren Sie uns bitte unter:

Naszym głównym celem jest satysfakcja klientów

W przypadku pytań prosimy o kontakt z przedstawicielem w danym kraju:

Naším hlavním cílem je spokojenost našich zákazníků!

V případě otázek nás prosím kontaktujte na:

Notre but premier est votre satisfaction!

pour toute question, contactez nous sur:

Nuestro objetivo principal es la satisfacción de nuestros clientes!

si tiene preguntas, por favor pónganse en contacto con nosotros en:

Il nostro principale obiettivo è la soddisfazione dei nostri clienti!

per eventuali domande per favore, ci contattino sotto:

CONTACT

expondo Polska sp. z o.o. sp. k.

ul. Nowy Kisielin-Innowacyjna 7

66-002 Zielona Góra | POLAND, EU

e-mail: info@expondo.com