



# OFFICE CHAIR

STAR\_SEAT\_21













USER MANUAL

BEDIENUNGSANLEITUNG  
INSTRUKCJA OBSŁUGI  
NÁVOD K POUŽITÍ  
MANUEL D'UTILISATION  
ISTRUZIONI PER L'USO  
MANUAL DE INSTRUCCIONES

CONTENT | INHALT | TREŚĆ | OBSAH | CONTENU | CONTENUTO | CONTENIDO

PRODUKTNAME	BÜROSTUHL
PRODUCT NAME	OFFICE CHAIR
NAZWA PRODUKTU	FOTEL DO BIURA OBROTOWY
NÁZEV VÝROBKU	KANCELÁŘSKÁ ŽIDLE
NOM DU PRODUIT	CHAISE DE BUREAU
NOME DEL PRODOTTO	SEDIA DA UFFICIO
NOMBRE DEL PRODUCTO	SILLA DE OFICINA
MODELL	
PRODUCT MODEL	
MODEL PRODUKTU	
MODEL VÝROBKU	STAR_SEAT_21
MODÈLE	
MODELLO	
MODELO	
IMPORTEUR	
IMPORTER	
IMPORTER	
DOVOZCE	EXPONDO POLSKA SP. Z O.O. SP. K.
IMPORTATEUR	
IMPORTATORE	
IMPORTADOR	
ADRESSE VON IMPORTEUR	
IMPORTER ADDRESS	
ADRES IMPORTERA	
ADRESA DOVOZCE	UL. NOWY KISIELIN-INNOWACYJNA 7, 66-002 ZIELONA GÓRA   POLAND, EU
ADRESSE DE L'IMPORTATEUR	
INDIRIZZO DELL'IMPORTATORE	
DIRECCIÓN DEL IMPORTADOR	

ZUSAMMENBAUEN DES PRODUKTS | ASSEMBLING THE EQUIPMENT | SKŁADANIE SPRZĘTU | SKLÁDÁNÍ ZAŘÍZENÍ  
 ASSEMBLAGE DU PRODUIT | MONTAGGIO DEL PRODOTTO | MONTAJE DEL PRODUCTO

<b>1</b>  <b>1x</b>	<b>2</b>  <b>1x</b>	<b>3</b>  <b>2x</b>	<b>4</b>  <b>5x</b>
<b>5</b>  <b>1x</b>	<b>6</b>  <b>1x</b>	<b>7</b>  <b>1x</b>	
<b>A</b>  <b>4xM6x20</b>	<b>B</b>  <b>4xM6x50</b>	<b>C</b>  <b>2xM6x30</b>	<b>D</b>  <b>4xM6x35</b>
<b>E</b>  <b>14xM6x16x1.2</b>	<b>F</b>  <b>1xM5</b>		

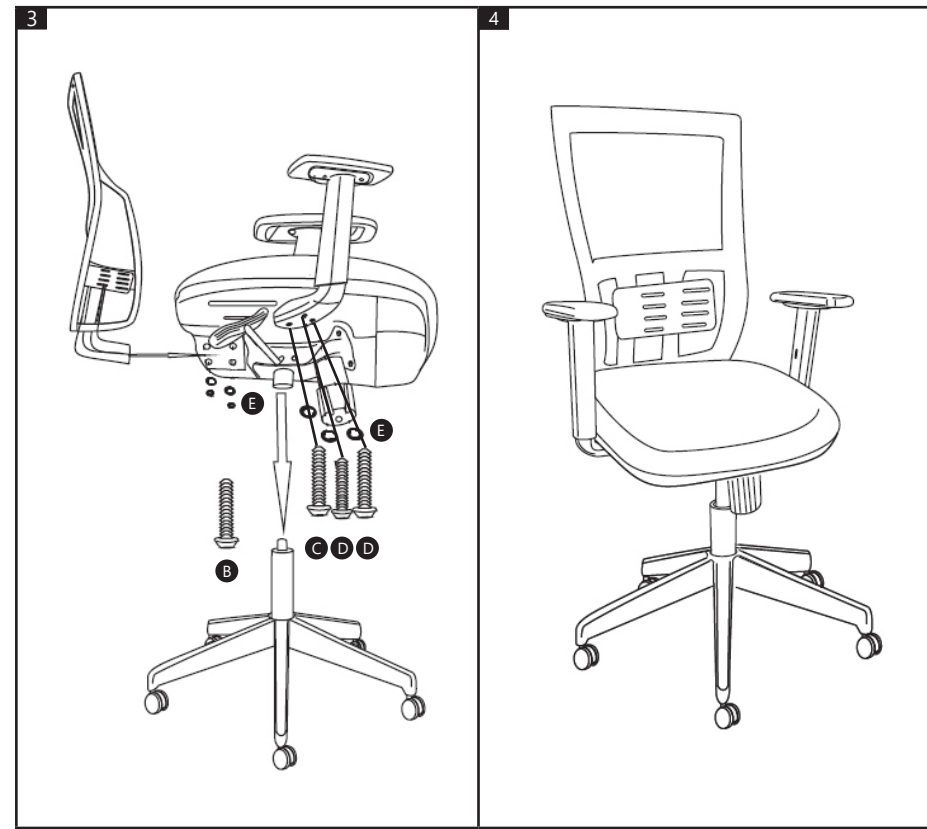
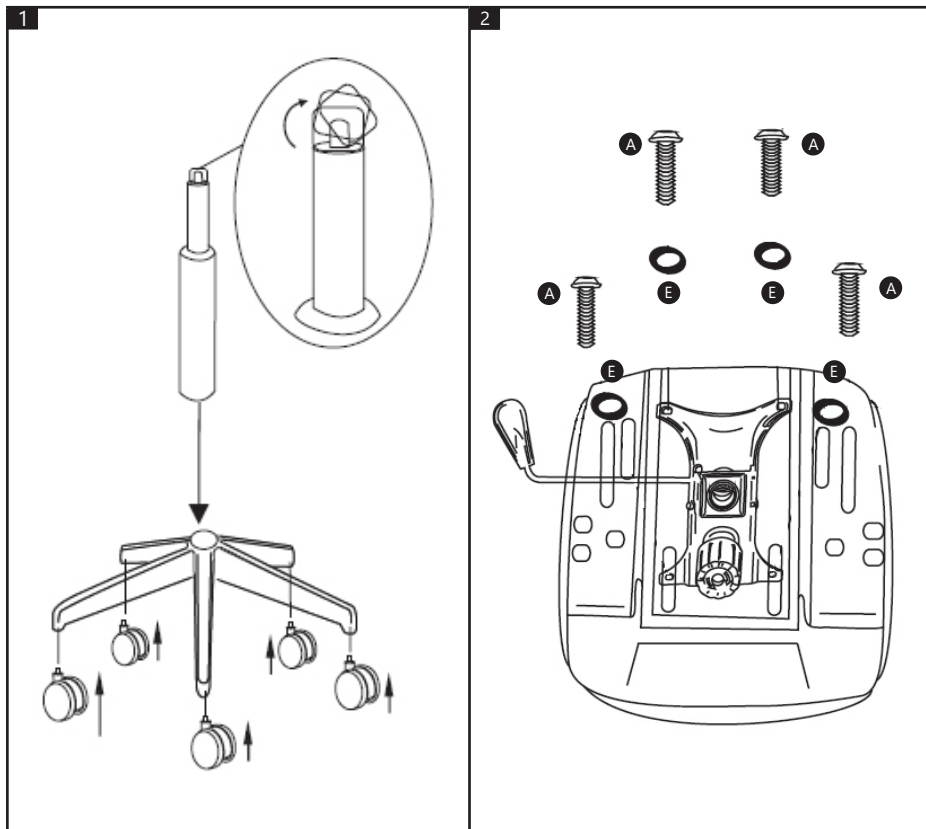

**WARNING!** Der Gasantrieb für die Sitzhöhenverstellung darf nur von geschultem Personal repariert werden.



**WARNING!** Only trained personnel may replace or repair gas cylinders for seat height adjustment.



**OSTRZEŻENIE!** Siłowniki gazowe regulacji wysokości siedziska mogą być naprawiane tylko przez przeszkolony personel.



**VAROVÁNÍ!** Součásti pro nastavení výšky sedadla mohou být vyměňovány nebo akumulovány pouze výškoleným personálem.



**ATTENTION !** Les vérins (à gaz) servant au réglage de la hauteur du siège doivent être réparés par un personnel qualifié seulement.



**ATTENZIONE!** Il meccanismo di sollevamento a gas per la regolazione dell'altezza della sedia può essere riparato solo da personale qualificato.



**iADVERTENCIA!** Únicamente el personal capacitado puede reemplazar o reparar los cilindros de gas para el ajuste de la altura del asiento.





UNSER HAUPTZIEL IST DIE ZUFRIEDENHEIT UNSERER KUNDEN!  
BEI FRAGEN KONTAKTIEREN SIE UNS BITTE UNTER:

OUR CUSTOMERS' SATISFACTION IS OUR MAIN GOAL!  
PLEASE CONTACT US WITH QUESTIONS AT:

NASZYM GŁÓWNYM CELEM JEST SATYSFAKCJA KLIENTÓW  
W PRZYPADKU PYTAŃ PROSIMY O KONTAKT Z PRZEDSTAWICIELEM  
W DANYM KRAJU:

NAŠÍM HLAVNÍM CÍLEM JE SPOKOJENOST NAŠICH ZÁKAZNÍKŮ! V PŘÍPADĚ  
OTÁZEK NÁS PROŠÍM KONTAKTUJTE NA:

NOTRE BUT PREMIER EST VOTRE SATISFACTION!  
POUR TOUTE QUESTION, CONTACTEZ NOUS SUR:

NUESTRO OBJETIVO PRINCIPAL ES LA SATISFACCIÓN DE NUESTROS CLIENTES!  
SI TIENE PREGUNTAS, POR FAVOR PÓNGANSE EN CONTACTO CON NOSTROS EN:

I NOSTRO PRINCIPALE OBIETTIVO È LA SODDISFAZIONE DEI NOSTRI CLIENTI!  
PER EVENTUALI DOMANDE PER FAVORE, CI CONTATTINO SOTTO:

---

## CONTACT

expondo Polska sp. z o.o. sp. k.  
ul. Nowy Kisielin-Innowacyjna 7  
66-002 Zielona Góra | Poland, EU  
e-mail: info@expondo.de