

USER MANUAL



physa

BEDIENUNGSANLEITUNG
INSTRUKCJA
NÁVOD K POUŽITÍ
MANUEL D'UTILISATION
ISTRUZIONI PER L'USO
MANUAL DE INSTRUCCIONES

PHYSA TRAPANI
PHYSA CARPI
PHYSA OLBIA

WASHBASIN

NAZWA PRODUKTU	UMYWALKA FRYZJERSKA
PRODUKTNAME	WASCHBECKEN
PRODUCT NAME	WASHBASIN
NOM DU PRODUIT	LAVABO
NOME DEL PRODOTTO	LAVANDINO
NOMBRE DEL PRODUCTO	LAVABO
NÁZEV VÝROBKU	UMYVADLO
MODEL PRODUKTU	
MODELL	
PRODUCT MODEL	PHYSA TRAPANI
MODÈLE	PHYSA CARPI
MODELLO	PHYSA OLBIA
MODELO	
MODEL VÝROBKU	
NAZWA PRODUCENTA	
NAME DES HERSTELLERS	
MANUFACTURER NAME	
NOM DU FABRICANT	expondo Polska sp. z o.o. sp. k.
NOME DEL PRODUTTORE	
NOMBRE DEL FABRICANTE	
NÁZEV VÝROBCE	
ADRES PRODUCENTA	
ANSCHRIFT DES HERSTELLERS	
MANUFACTURER ADDRESS	
ADRESSE DU FABRICANT	ul. Dekoracyjna 3, 65-155 Zielona Góra Poland, EU
INDIRIZZO DEL FORNITORE	
DIRECCIÓN DEL FABRICANTE	
ADRESA VÝROBCE	

PHYSA TRAPANI

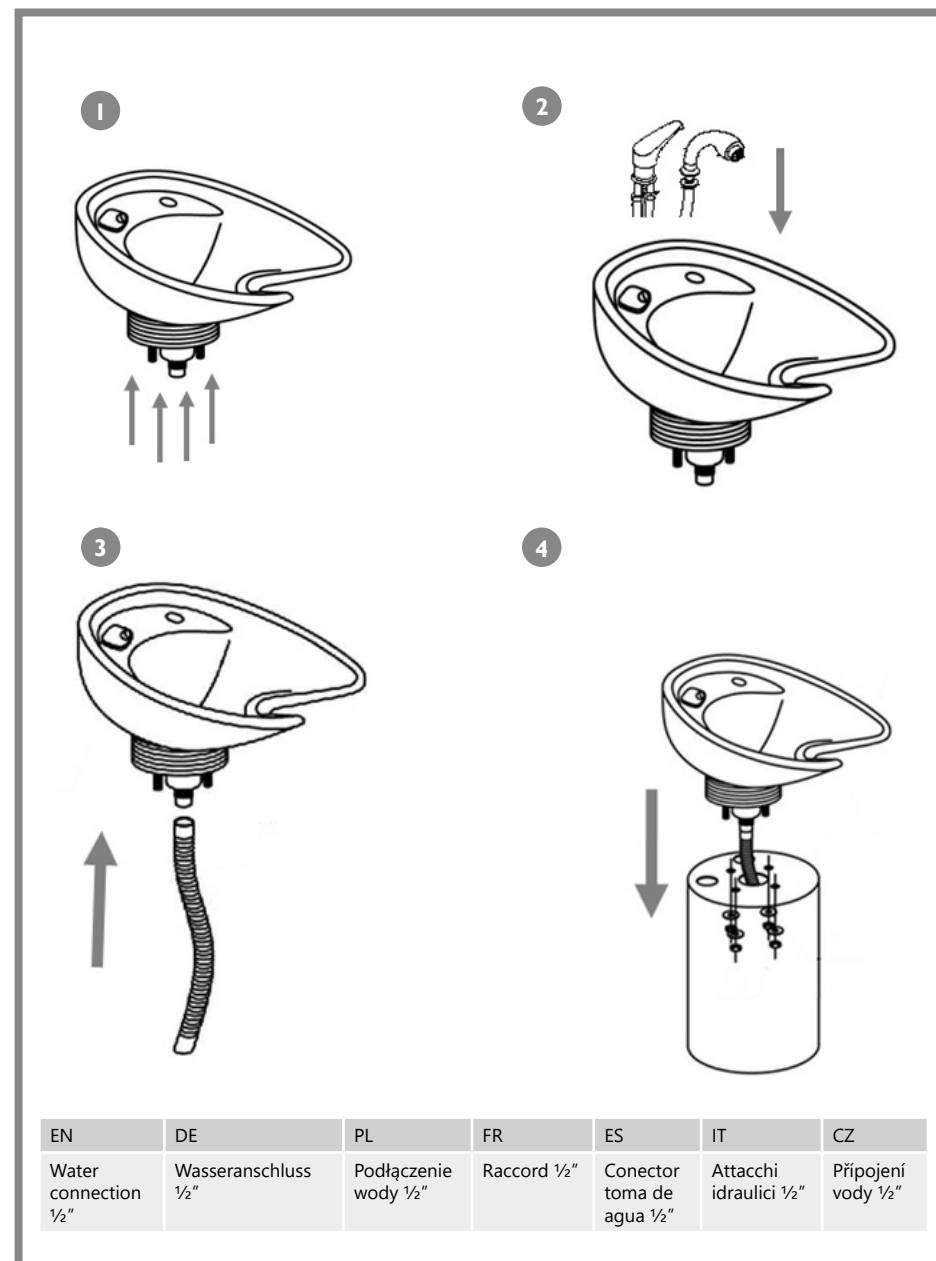

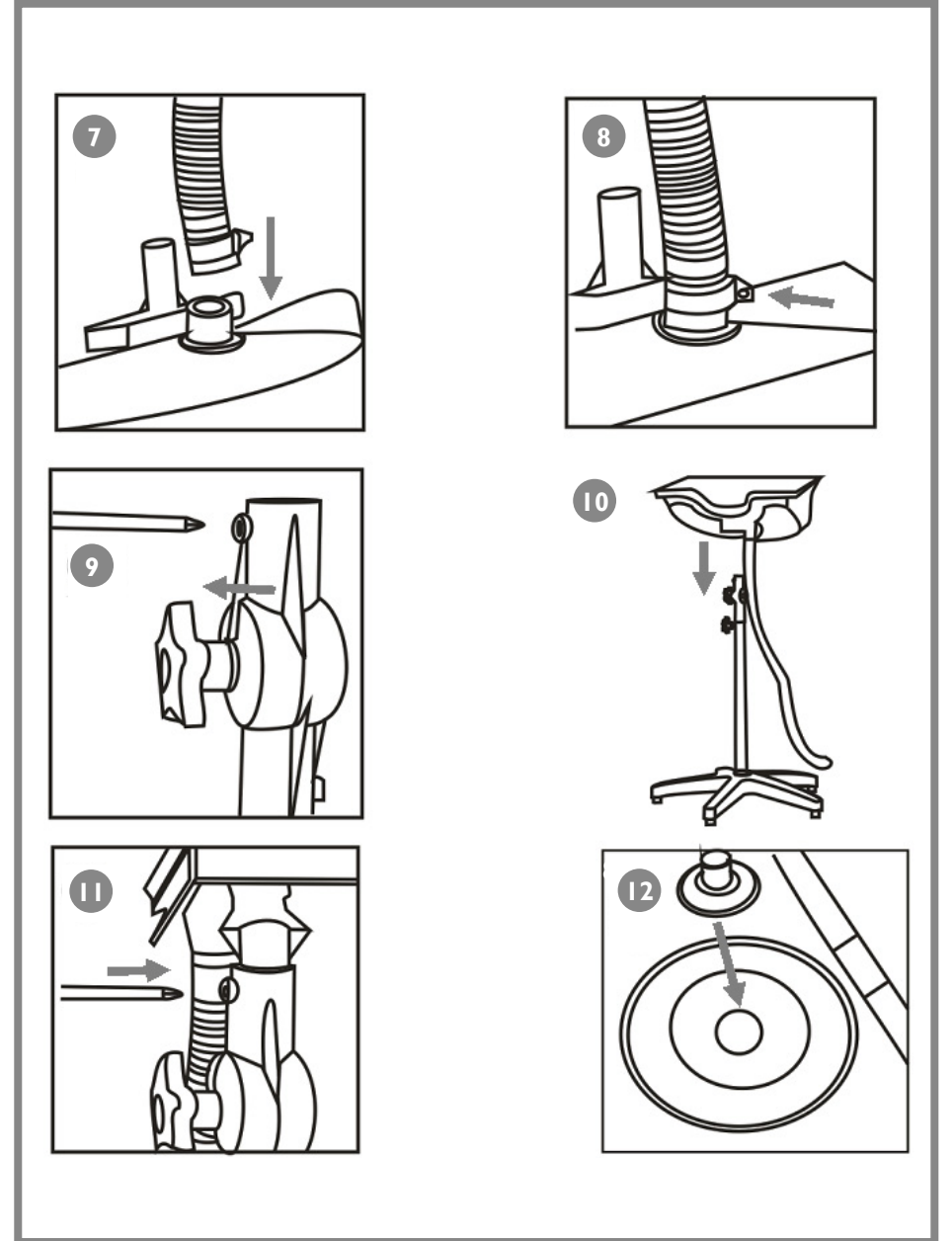
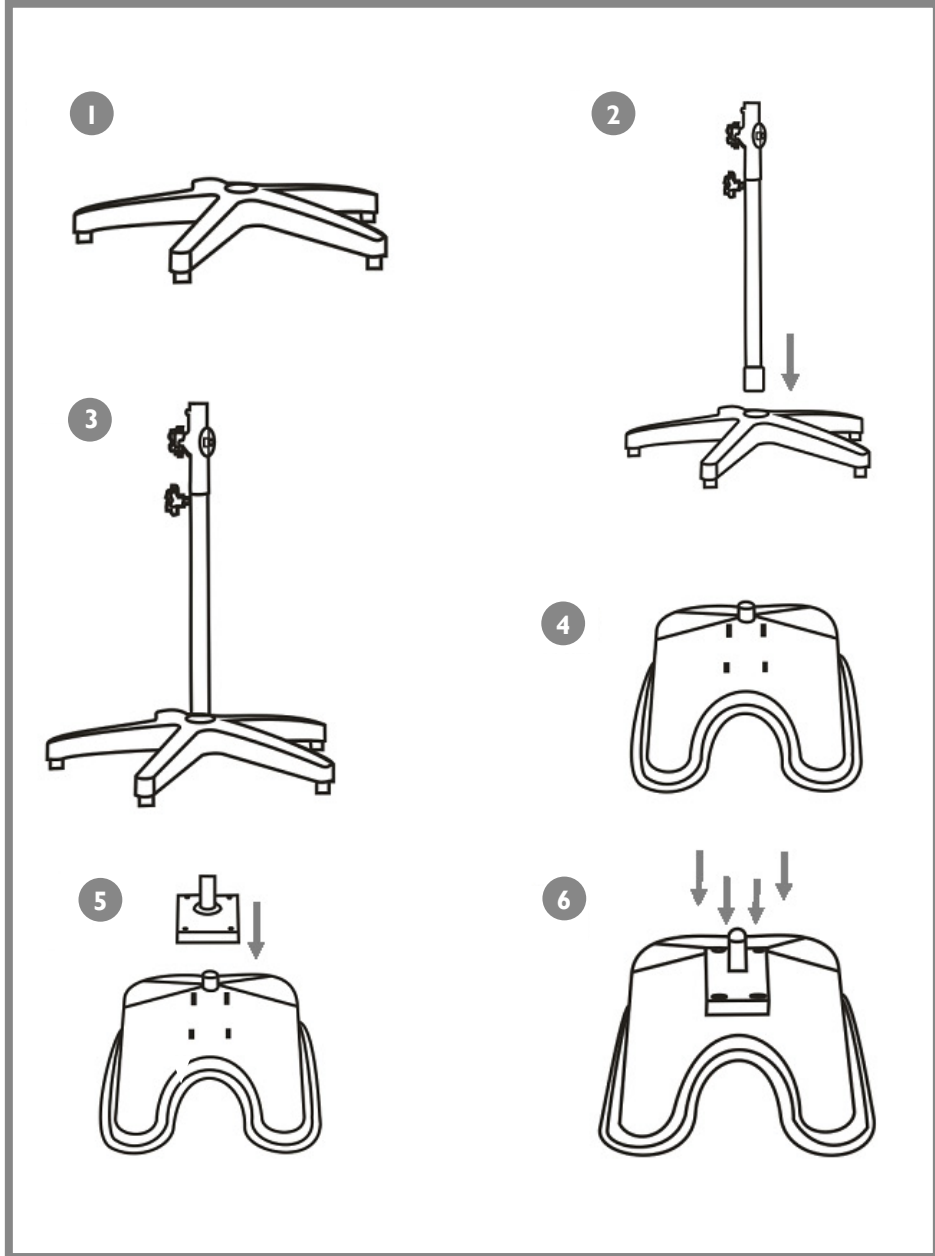

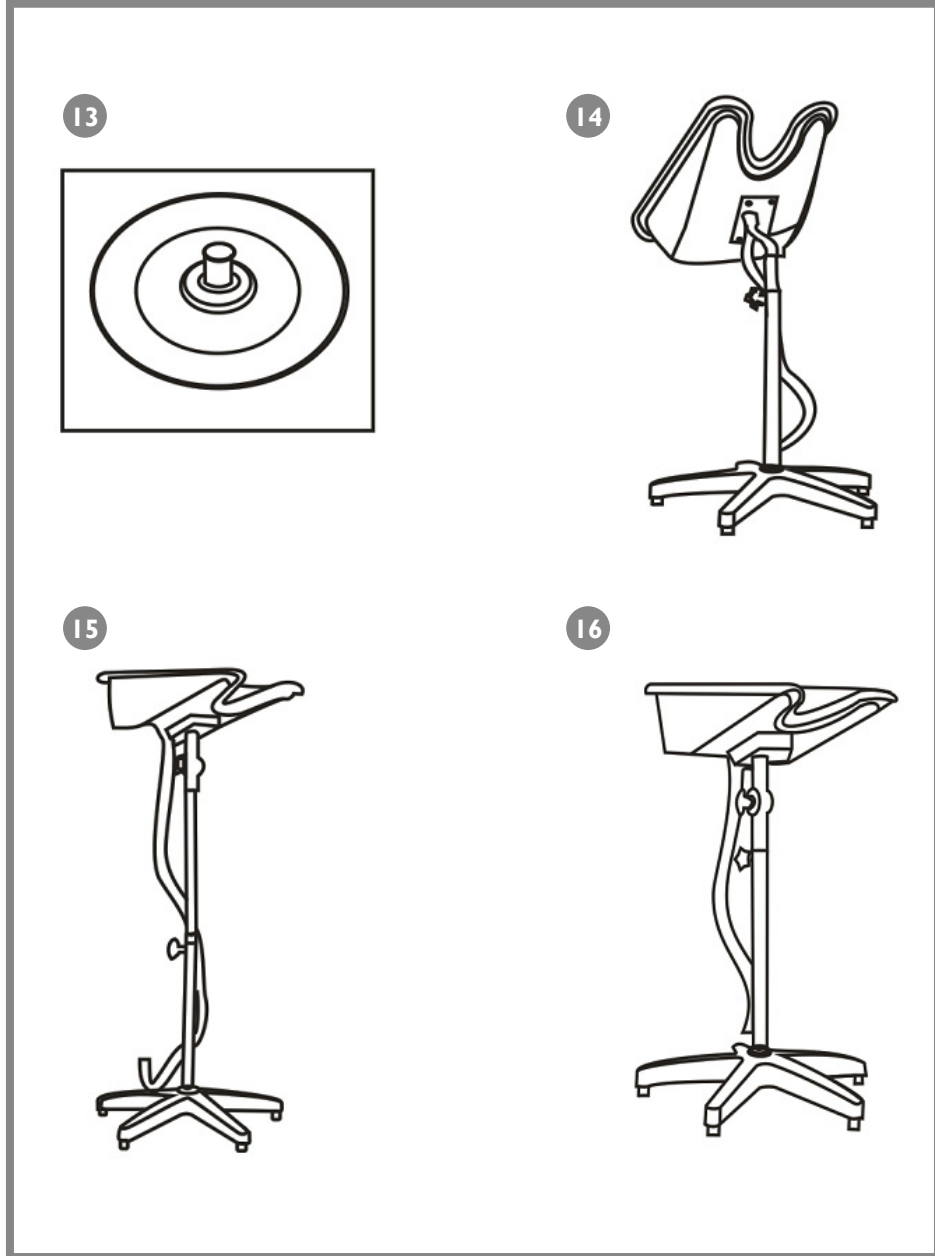

PHISA OLBIA

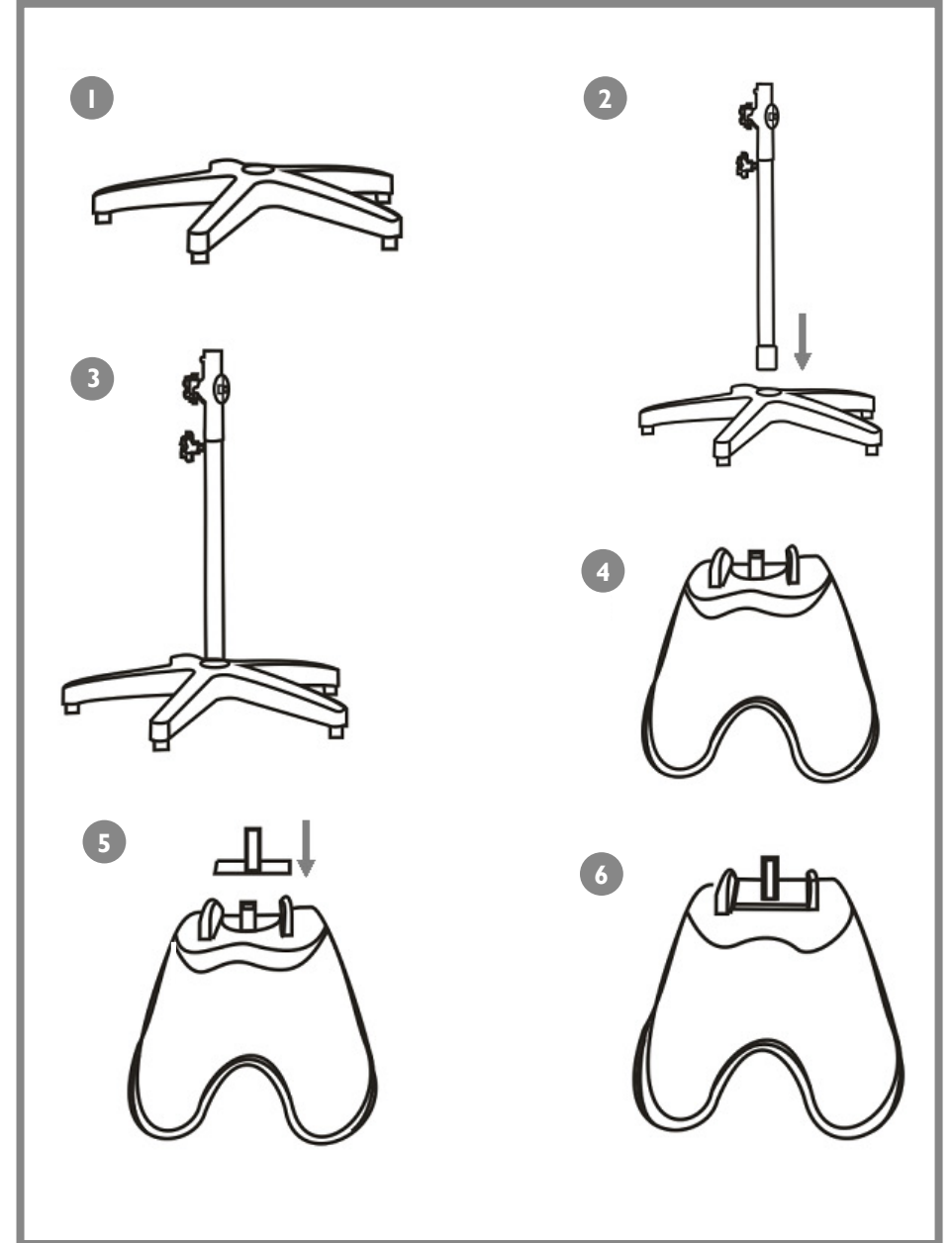

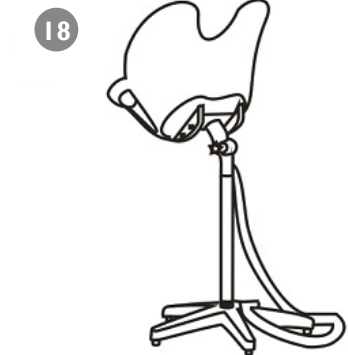
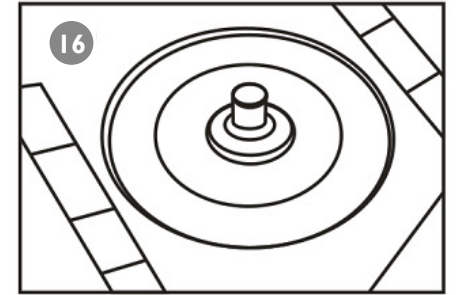
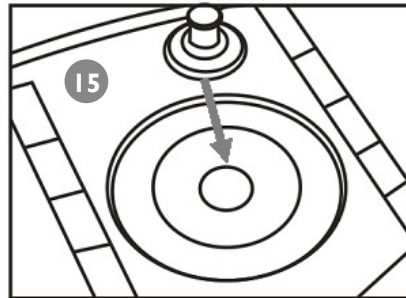
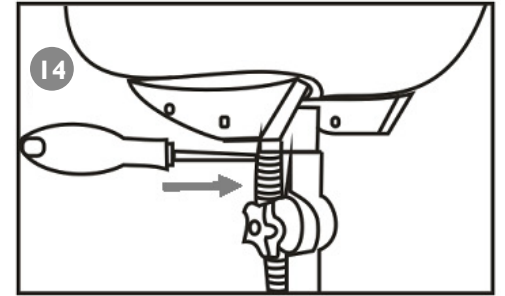
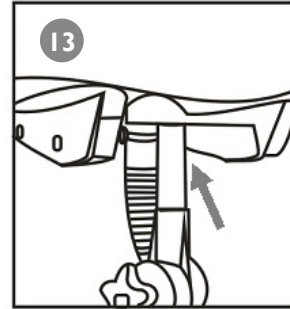
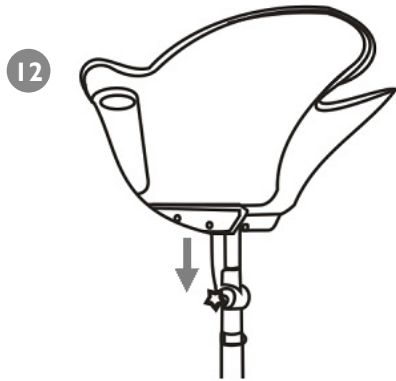
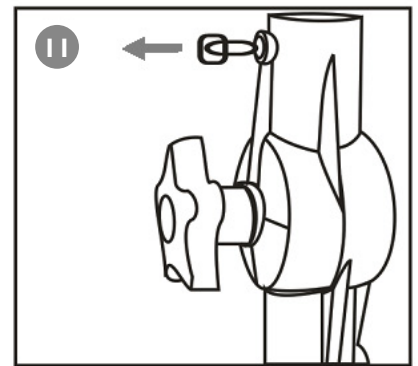
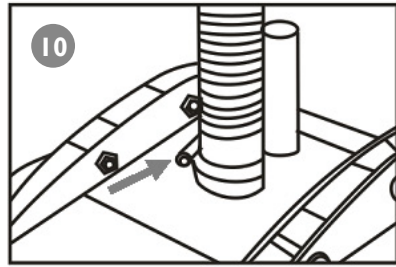
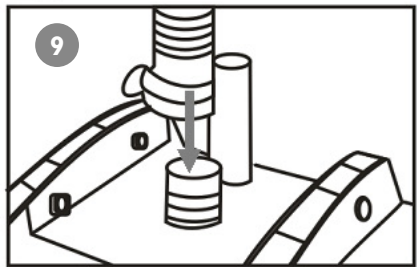
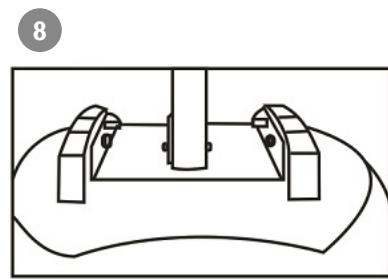
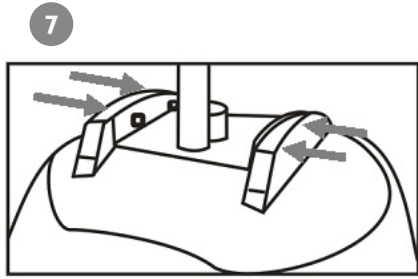



Our customers' satisfaction is our main goal!
Please contact us with questions AT:

Unser Hauptziel ist die Zufriedenheit unserer Kunden!
bei fragen kontaktieren Sie uns bitte unter:

Naszym głównym celem jest satysfakcja klientów
W przypadku pytań prosimy o kontakt z przedstawicielem w danym kraju:

Naším hlavním cílem je spokojenost našich zákazníků!
V případě otázek nás prosím kontaktujte na:

Notre but premier est votre satisfaction!
pour toute question, contactez nous sur:

Nuestro objetivo principal es la satisfacción de nuestros clientes!
si tiene preguntas, por favor pónganse en contacto con nosotros en:

I nostro principale obiettivo è la soddisfazione dei nostri clienti!
per eventuali domande per favore, ci contattino sotto:

CONTACT

expondo Polska sp. z o.o. sp. k.
ul. Dekoracyjna 3
65-155 Zielona Góra | Poland, EU
e-mail: info@expondo.de