



ROYAL
c a t e r i n g

BEDIENUNGSANLEITUNG

User manual | Manuel d'utilisation | Istruzioni per l'uso | Manual de instrucciones | Instrukcja | Návod k použití

HÄNGE REGAL

- **RCHC-I20/38**





NAZWA PRODUKTU:	SZAFKA WISZĄCA
PRODUKTNAME:	HÄNGEREGAL
PRODUCT NAME:	HANGING SHELF
NOM DU PRODUIT:	ETAGÈRE
NOME DEL PRODOTTO:	SCAFFALE A MURO
NOMBRE DEL PRODUCTO:	ESTANTERÍA
NÁZEV VÝROBKU	NÁSTĚNNÁ SKŘÍŇ
MODEL PRODUKTU	
MODELL	
PRODUCT MODEL	
MODÈLE	RCHC-120/38
MODELLO	
MODELO	
MODEL VÝROBKU	
NAZWA PRODUCENTA	
NAME DES HERSTELLERS	
MANUFACTURER NAME	
NOM DU FABRICANT	EXPONDO POLSKA SP. Z O.O. SP. K.
NOME DEL PRODUTTORE	
NOMBRE DEL FABRICANTE	
NÁZEV VÝROBCE	
ADRES PRODUCENTA	
ANSCHRIFT DES HERSTELLERS	
MANUFACTURER ADDRESS	
ADRESSE DU FABRICANT	UL. DEKORACYJNA 3, 65-155 ZIELONA GÓRA POLAND, EU
INDIRIZZO DEL FORNITORE	
DIRECCIÓN DEL FABRICANTE	
ADRESA VÝROBCE	

INHALT | CONTENT | CONTENU | CONTENIDO | TREŠĆ | CONTENUTO

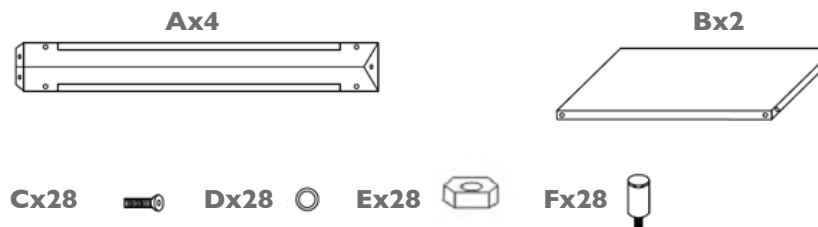

EN: Connect A and B by mounting C (screws), D (washers) and E (nuts). Fix the shelf to the wall using expansion bolts F.

DE: Verbinden Sie A und B mit den Schrauben C, Unterlegscheiben D und den Muttern E. Befestigen Sie das Wandboard mit den Dehnschrauben an die Wand.

PL: Połączyć A oraz B poprzez mocowanie śrubami C, podkładkami D i nakrętkami E. Półkę zamocować do ściany przy pomocy kotew F.

FR: Connecter A et B avec les vis C, les rondelles D et les écrous E. Fixez l'étagère au mur avec les boulons F.

IT: Collegare A e B con le viti C, le rondelle D e i dadi E. Fissare la mensola al muro con le viti con gambo scaricato.

ES: Una A con B por medio de los tornillos C, las arandelas D y las tuercas E. Fije la estantería a la pared mediante los tacos de expansión F.

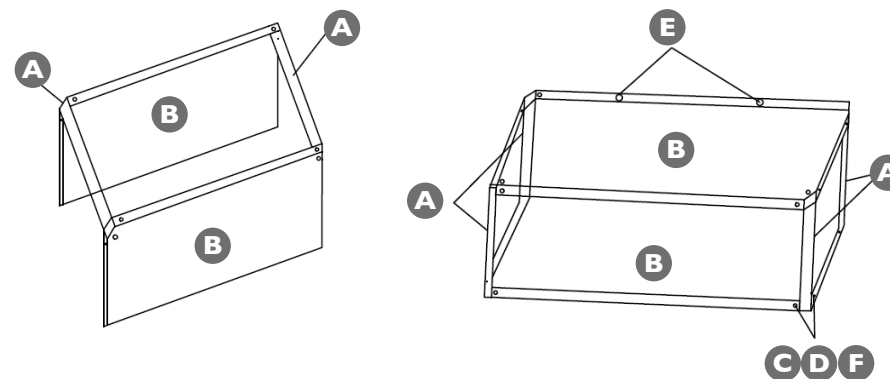

CZ: Připojte A a B se šrouby C, podložkou D a maticemi. Upevněte polici s roztahovacím šroubem na stěnu.







NAMEPLATE TRANSLATIONS

Manufacturer: expondo Polska sp. z o.o. sp. k. ul. Dekoracyjna 3, 65-155 Zielona Góra Poland, EU		
Product name	Hanging shelf	 DESIGN MADE IN GERMANY expondo.de
Model	RCHC-120/38	
Production year		
Serial No.		

Hersteller: expondo Polska sp. z o.o. sp. k. ul. Dekoracyjna 3, 65-155 Zielona Góra Poland, EU		
Produktname	Hängeregale	 DESIGN MADE IN GERMANY expondo.de
Modell	RCHC-120/38	
Produktionsjahr		
Ordnungsnummer		

Producent: expondo Polska sp. z o.o. sp. k. ul. Dekoracyjna 3, 65-155 Zielona Góra Poland, EU		
Nazwa produktu	Szafka wisząca	 DESIGN MADE IN GERMANY expondo.de
Model produktu	RCHC-120/38	
Rok produkcji		
Numer serii		

Fabriquant: expondo Polska sp. z o.o. sp. k. ul. Dekoracyjna 3, 65-155 Zielona Góra Poland, EU		
Nom du produit	Etagère	 DESIGN MADE IN GERMANY expondo.de
Modèle	RCHC-120/38	
Année de production		
Numéro de série		

Produttore: expondo Polska sp. z o.o. sp. k. ul. Dekoracyjna 3, 65-155 Zielona Góra Poland, EU		
Nome del prodotto	Scaffale a muro	 DESIGN MADE IN GERMANY expondo.de
Modello	RCHC-120/38	
Anno di produzione		
Numero di serie		

Fabricante: expondo Polska sp. z o.o. sp. k. ul. Dekoracyjna 3, 65-155 Zielona Góra Poland, EU		
Nombre del producto	Estantería	 DESIGN MADE IN GERMANY expondo.de
Modelo	RCHC-120/38	
Año de producción		
Número de serie		

Výrobce: expondo Polska sp. z o.o. sp. k. ul. Dekoracyjna 3, 65-155 Zielona Góra Poland, EU		
Název výrobku	Nástěnná skříň	 DESIGN MADE IN GERMANY expondo.de
Model výrobku	RCHC-120/38	
Rok výroby		
Sériové číslo		





UNSER HAUPTZIEL IST DIE ZUFRIEDENHEIT UNSERER KUNDEN!
BEI FRAGEN KONTAKTIEREN SIE UNS BITTE UNTER:

OUR CUSTOMERS' SATISFACTION IS OUR MAIN GOAL!
PLEASE CONTACT US WITH QUESTIONS AT:

NASZYM GŁÓWNYM CELEM JEST SATYSFAKCJA KLIENTÓW
W PRZYPADKU PYTAŃ PROSIMY O KONTAKT Z PRZEDSTAWICIELEM
W DANYM KRAJU:

NOTRE BUT PREMIER EST VOTRE SATISFACTION!
POUR TOUTE QUESTION, CONTACTEZ NOUS SUR:

NUESTRO OBJETIVO PRINCIPAL ES LA SATISFACCIÓN DE NUESTROS CLIENTES!
SI TIENE PREGUNTAS, POR FAVOR PÓNGANSE EN CONTACTO CON NOSTROS EN:

I NOSTRO PRINCIPALE OBIETTIVO È LA SODDISFAZIONE DEI NOSTRI CLIENTI!
PER EVENTUALI DOMANDE PER FAVORE, CI CONTATTINO SOTTO:

CONTACT

expondo Polska sp. z o.o. sp. k.

ul. Dekoracyjna 3
65-155 Zielona Góra | Poland, EU

e-mail: info@expondo.de